

PRZEM. ROZWIĄZANIE
RZĘDNA TERENU ISTN.
RZĘDNA DNA KANAŁU
ZAGŁĘBIENIE DNA KANAŁU
ZAGŁĘBIENIE DNA WYKOPU
SPADKI, DŁUGOŚCI
ŚREDNICA, MATERIAŁ
ODLEGŁOŚCI
HEKTOMETRY

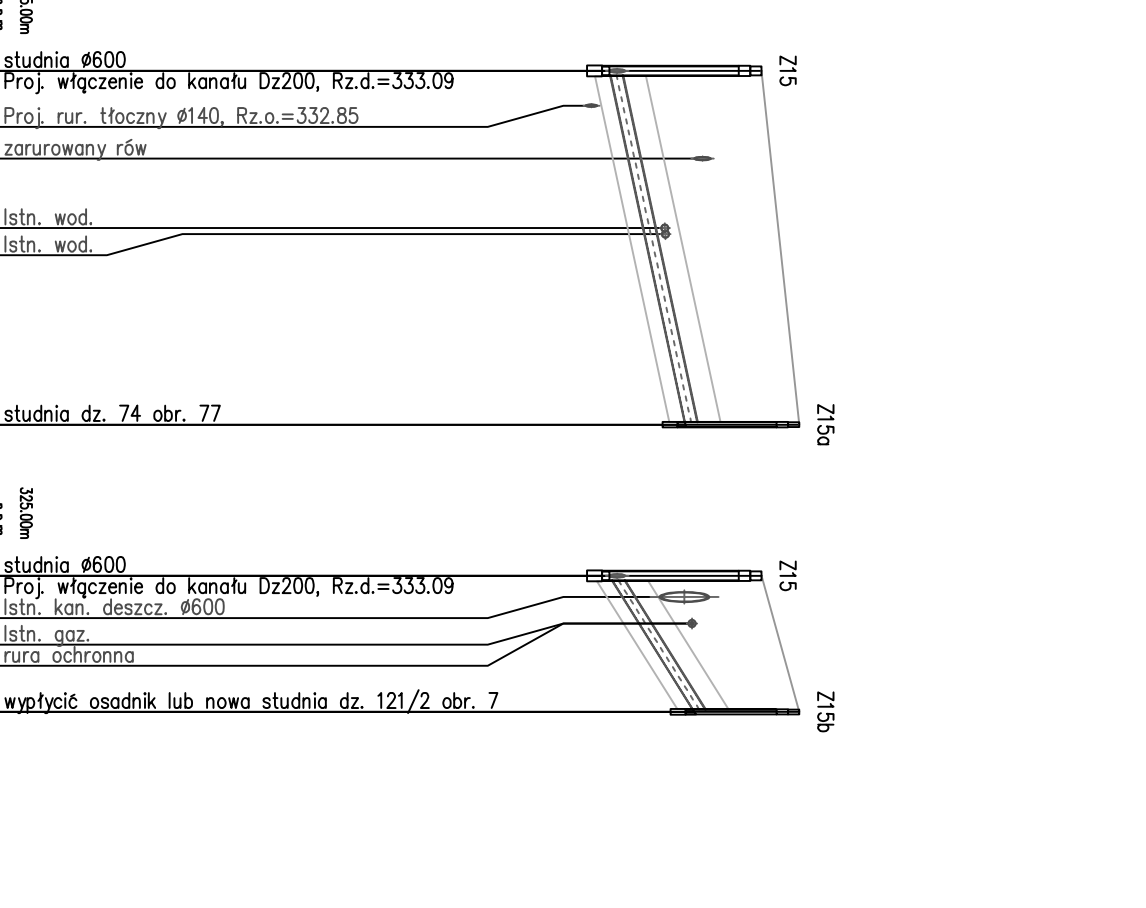
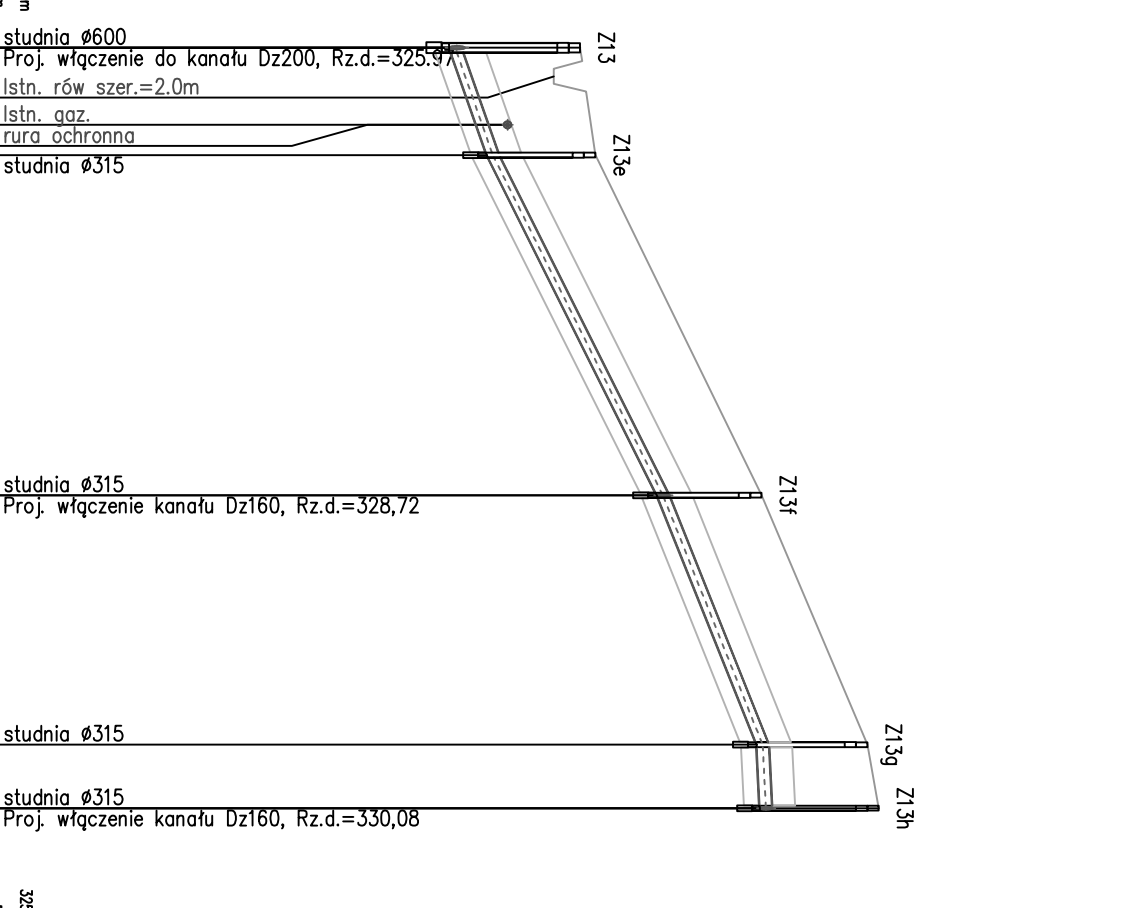
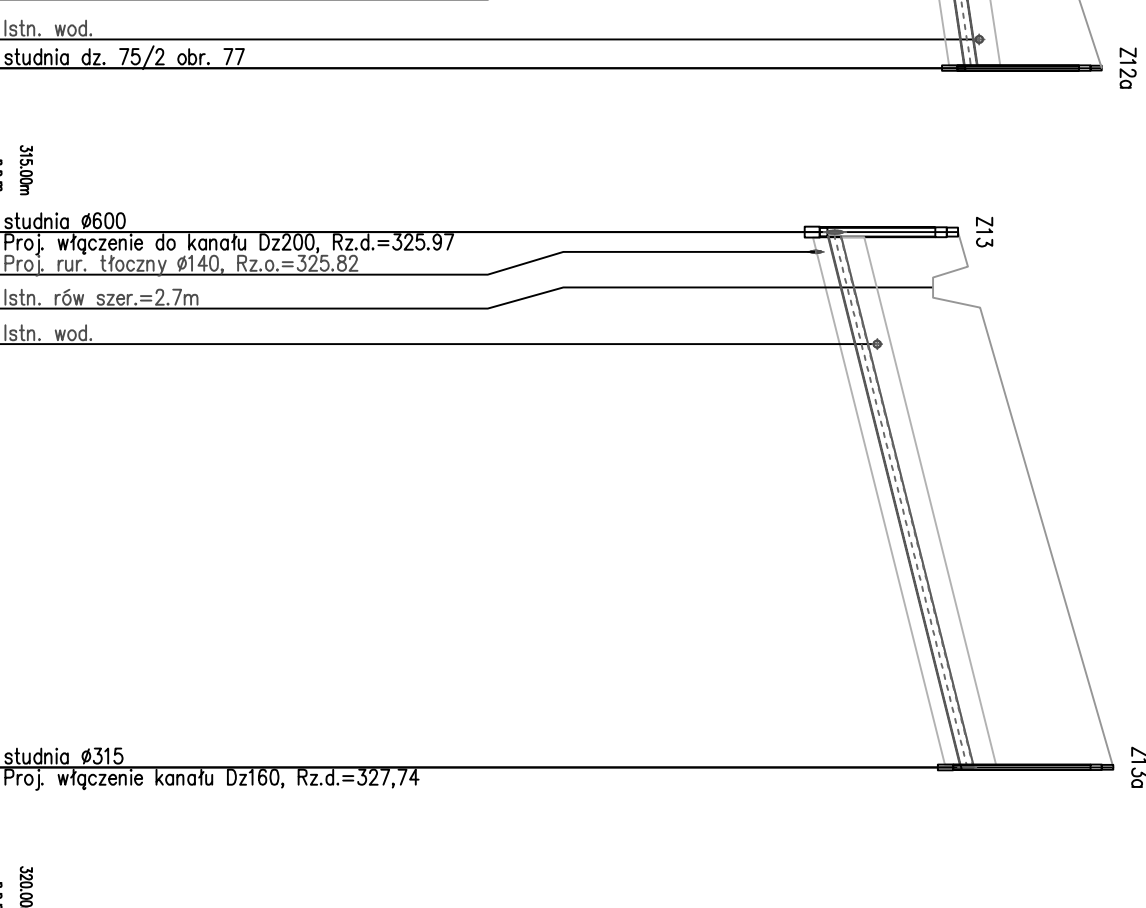
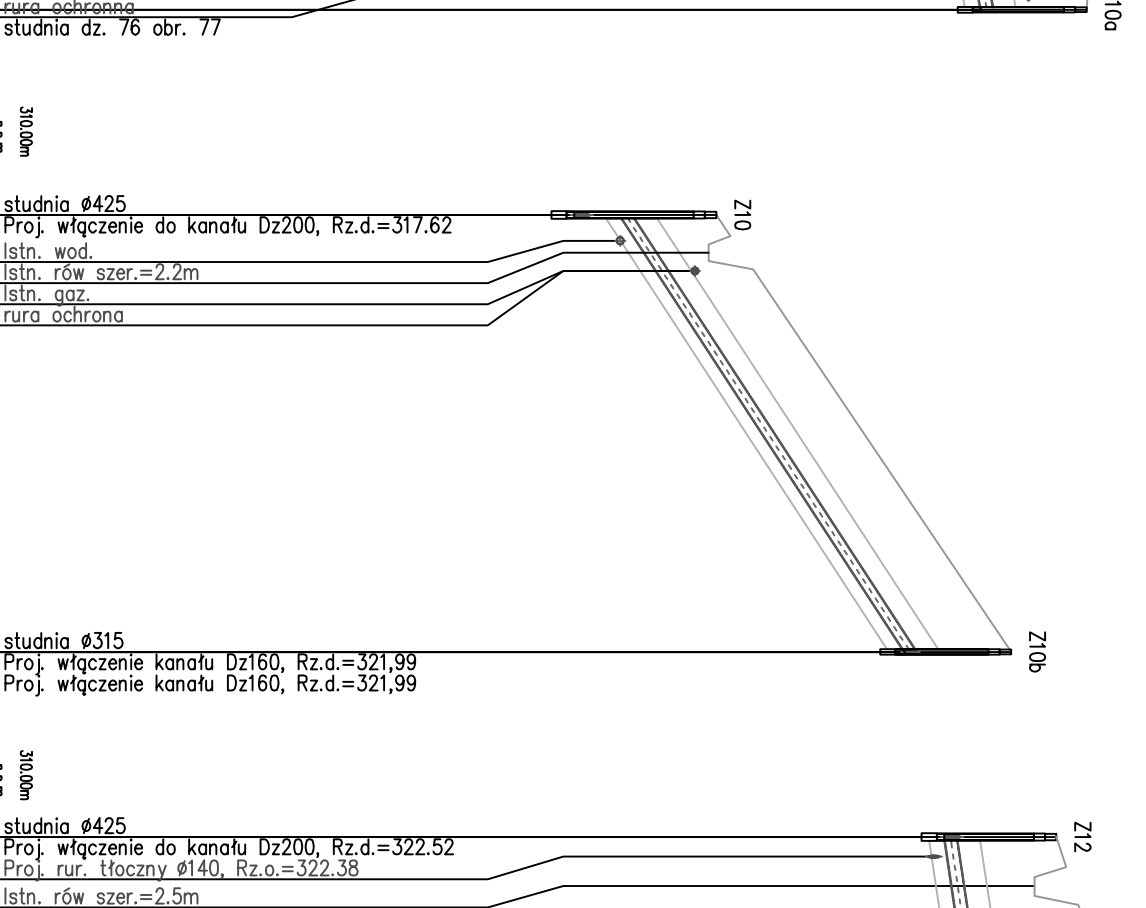
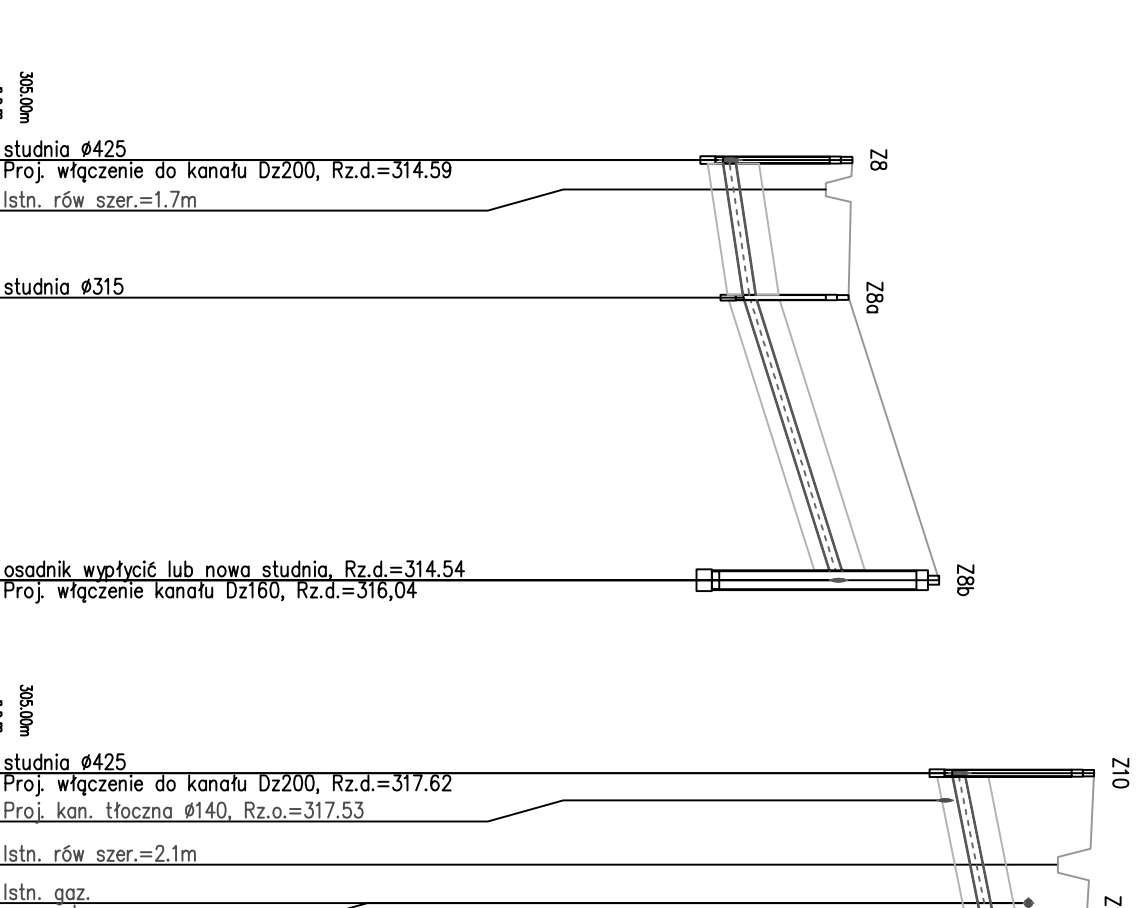
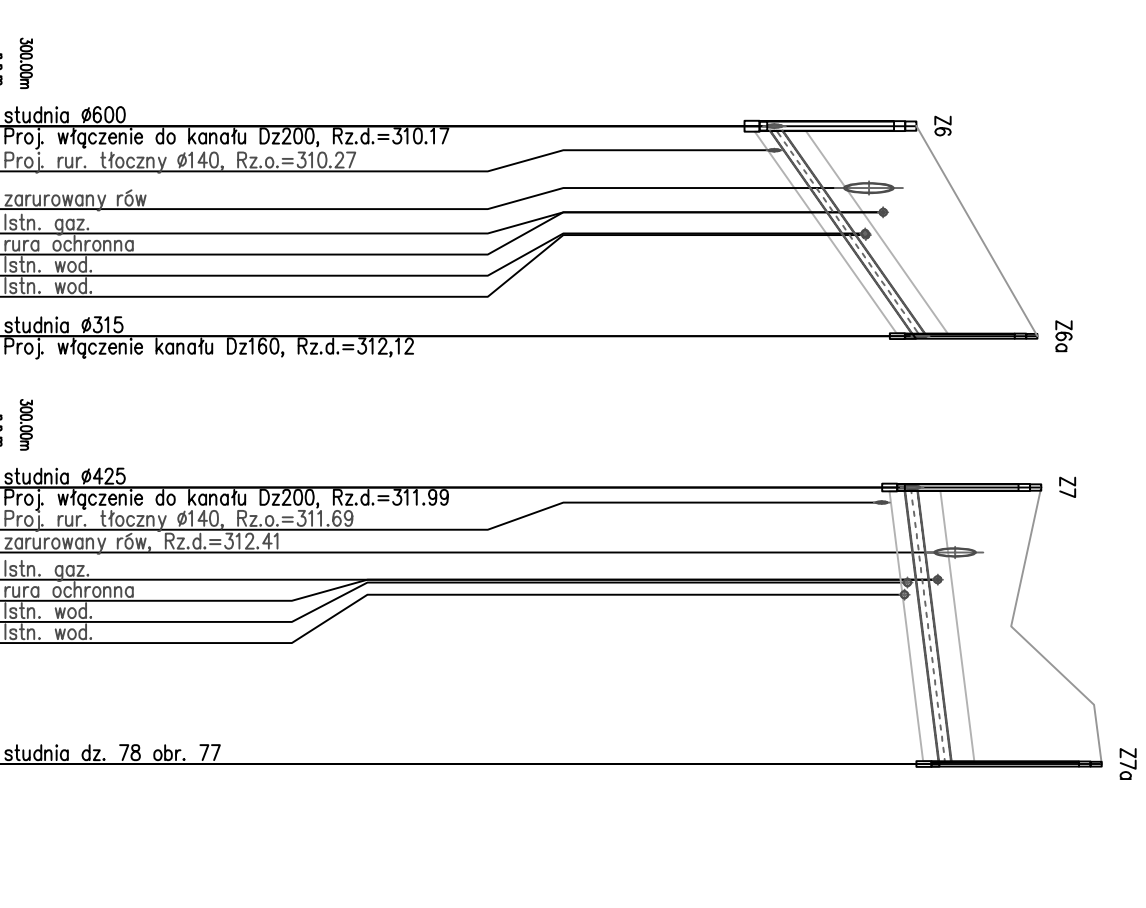
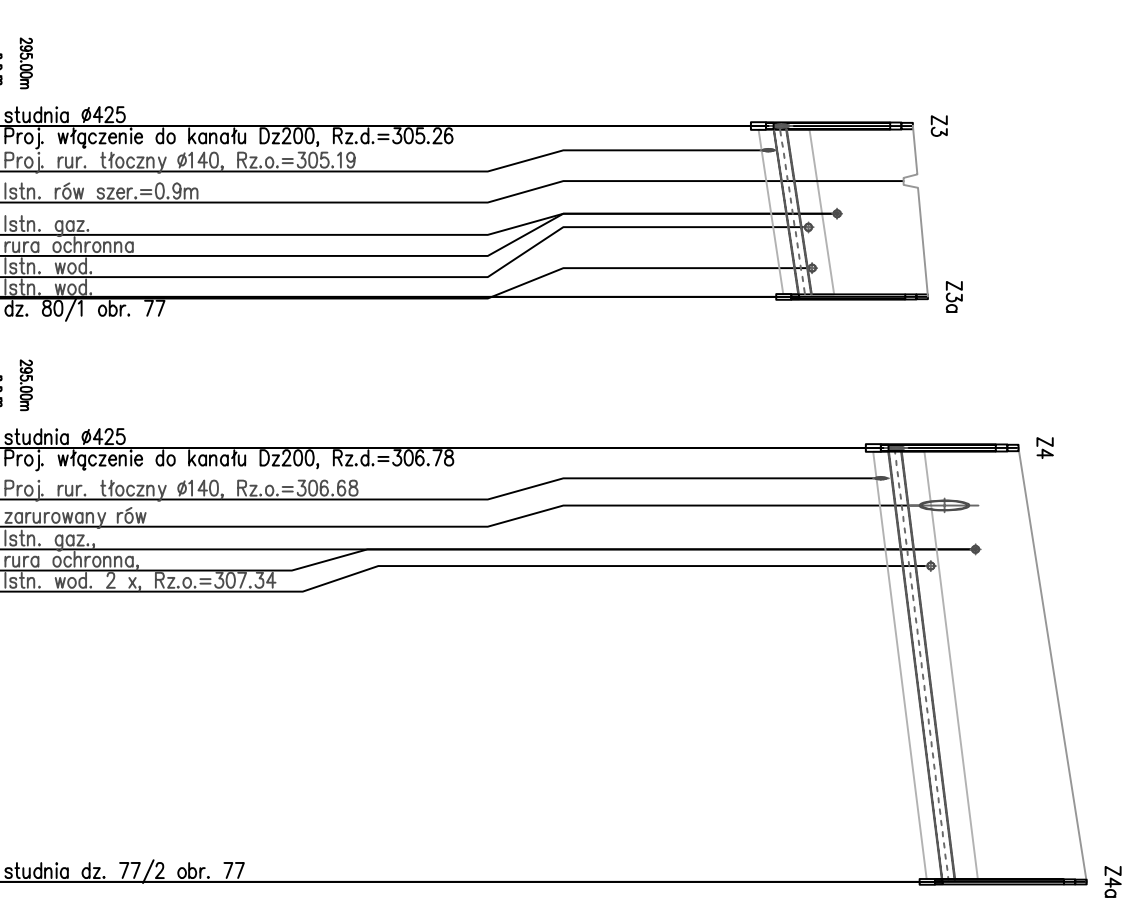
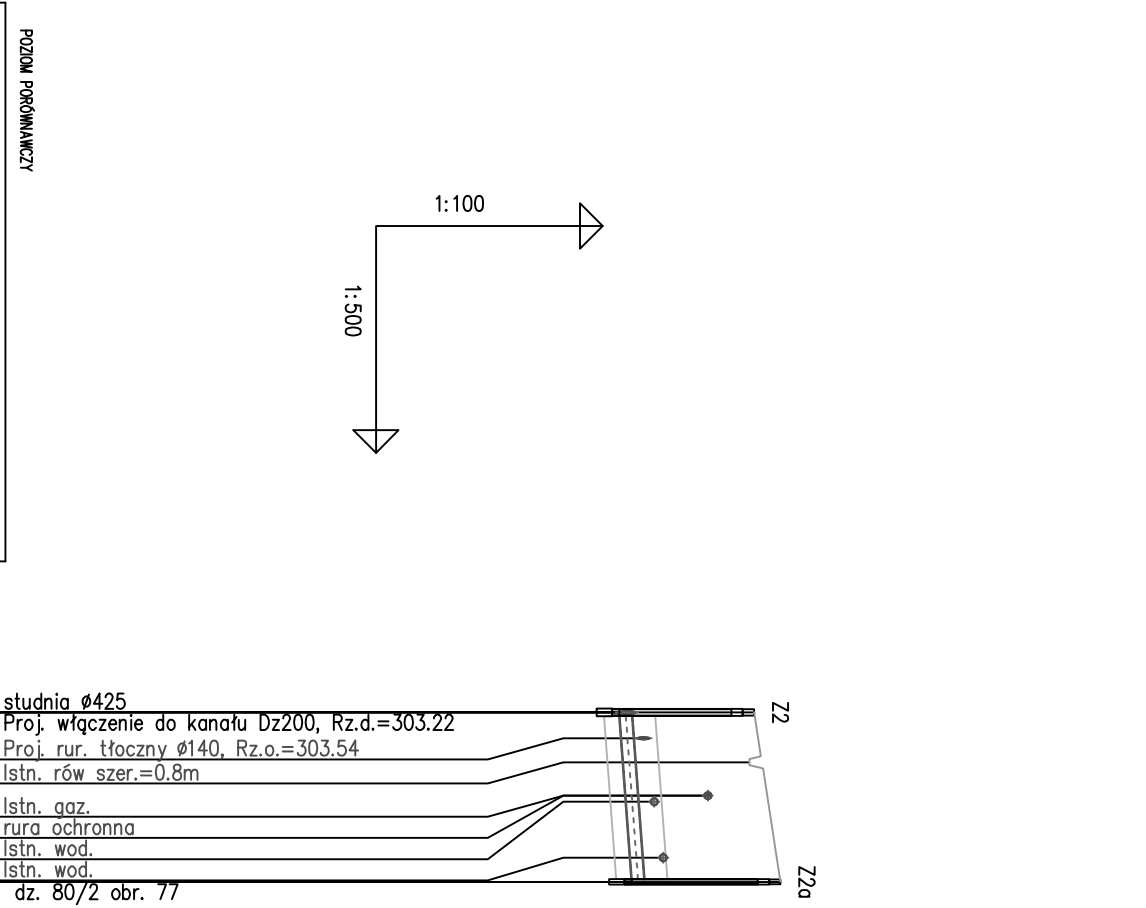
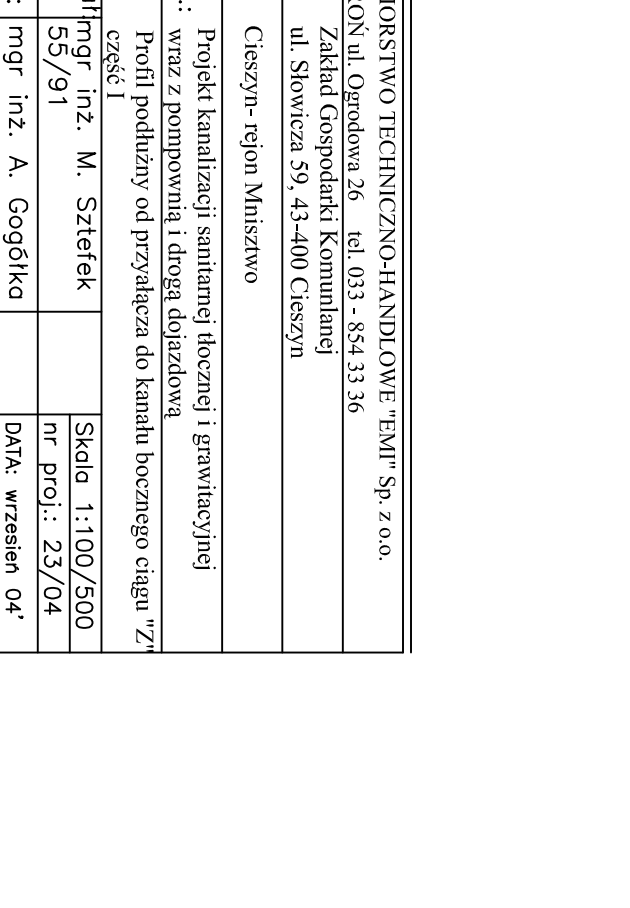
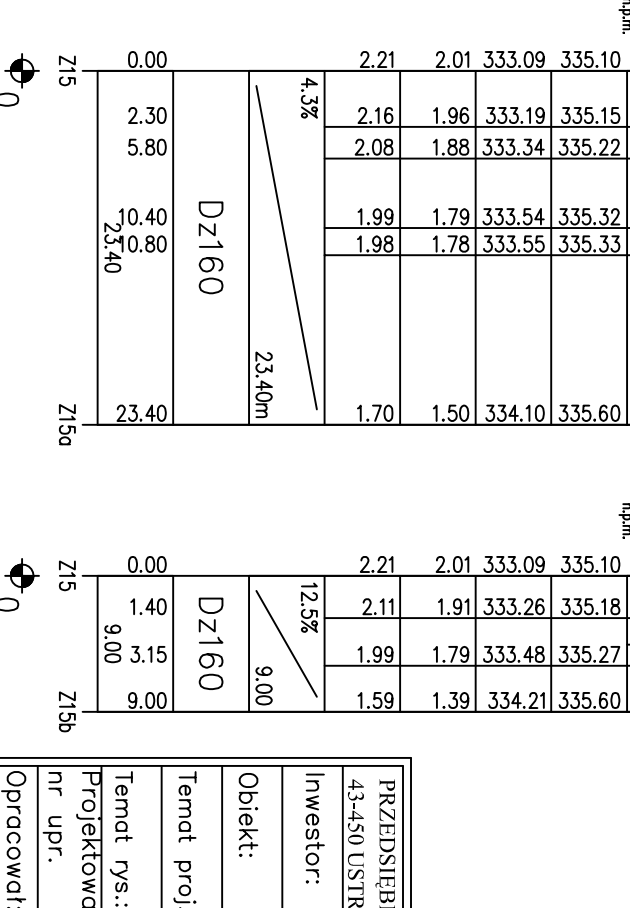
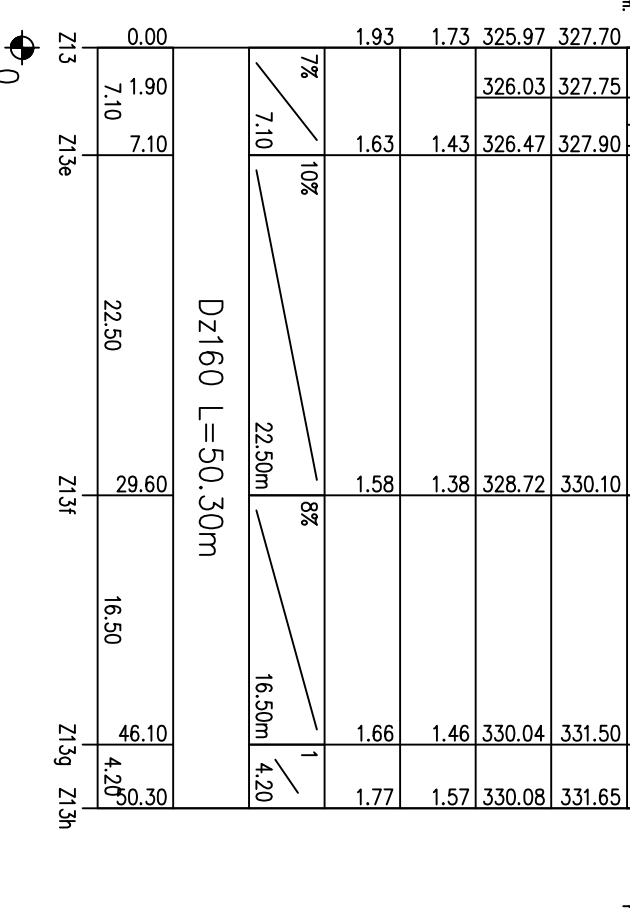
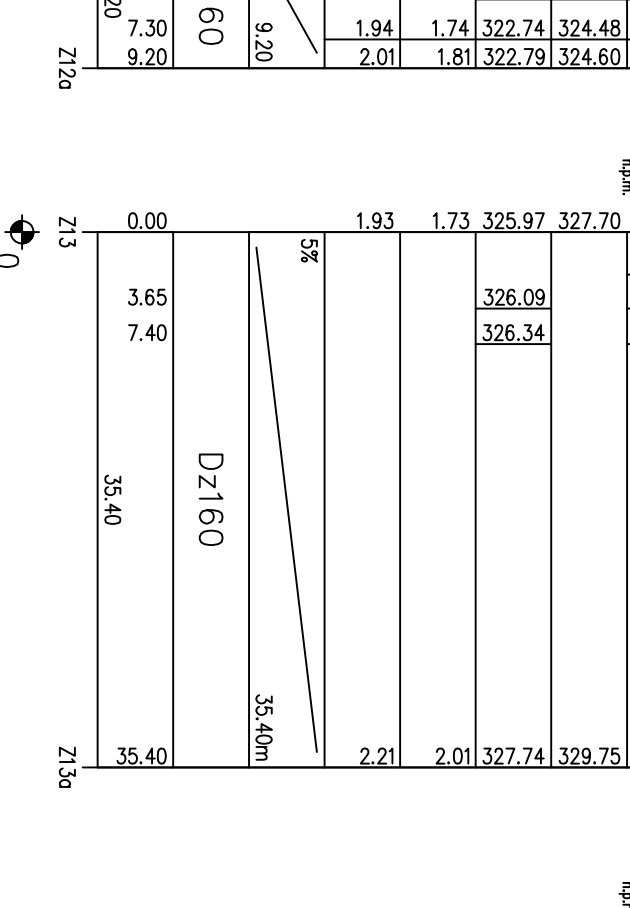
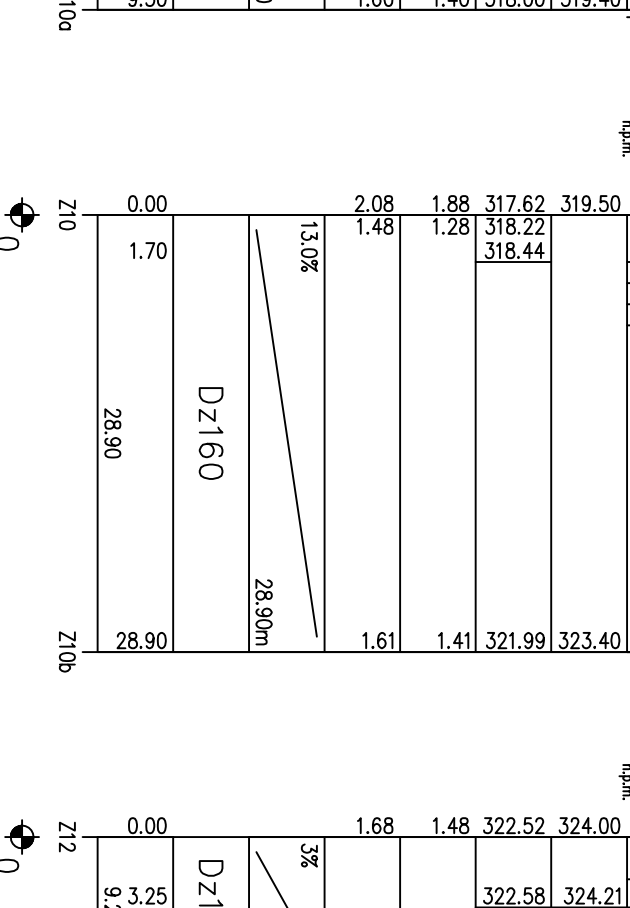
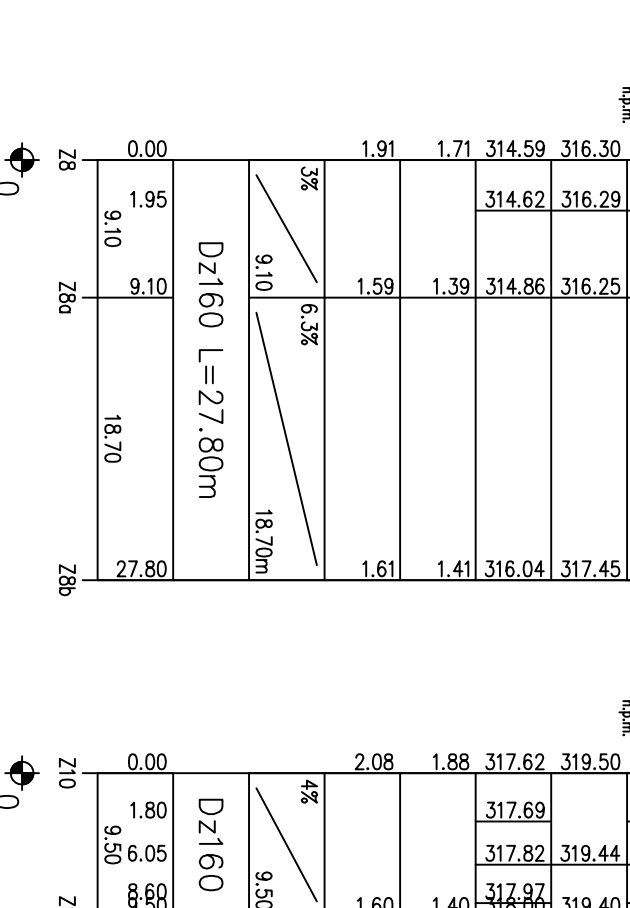
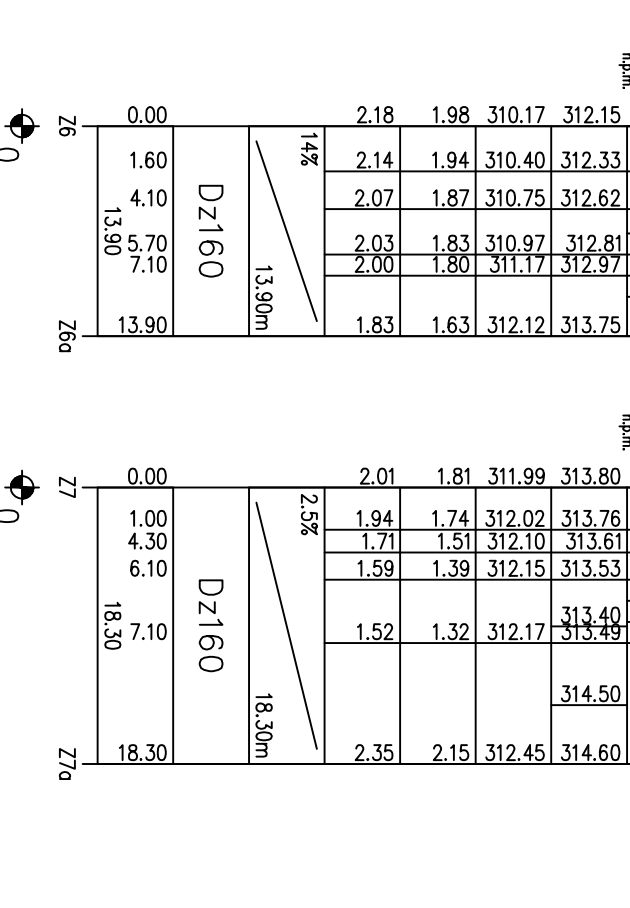
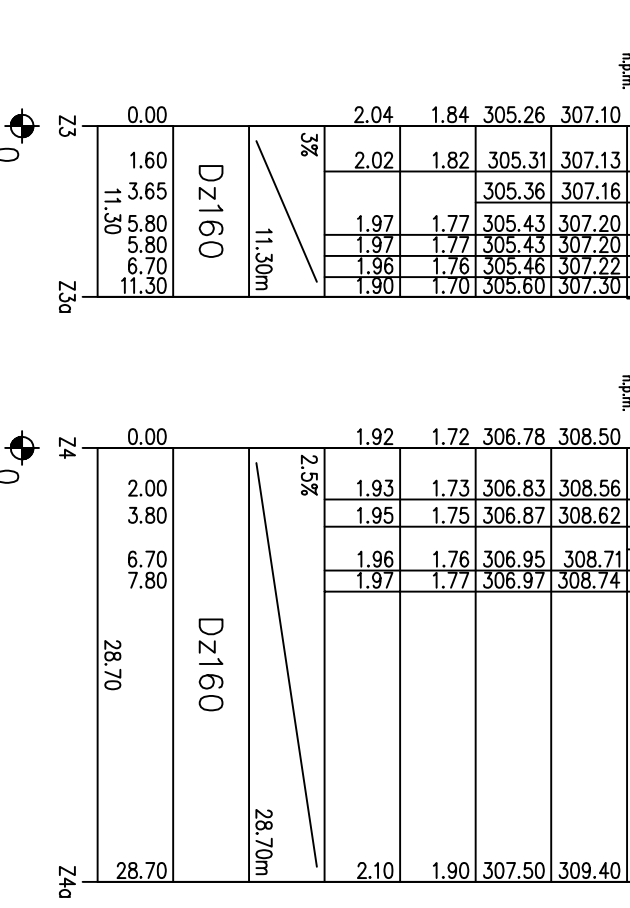

PRZEDSIĘBIORSTWO TECHNICZNO-HANDELOWE "EM" Sp. z o.o.
43-450 USTRON, ul. Orłowska 26, tel. 033-854 33 36
INWESTOR: Zakład Gospodarki Komunalnej
ul. Słowicza 57, 43-400 CIESZYŃ
Obiekt: Cieszyń - region Miastwo
Temat proj.: Projekt kanalizacji sanitarnej tłocznej i gravitacyjnej wraz z podpiwnicami i drogią dojazdową
Temat rys.: Profil podpiwnicy od przyłącza do kanału bocznego ciągu "Z"
Projektant: mgr inż. M. Szałefek
nr upr.: 55/91
Opracował: mgr inż. A. Gogółka
nr upr.: 169/81
nr rys.: 24